

USER MANUAL

Manual version 1.00 (30.07.2020 from software v1.00)



RT-18 VETRO OM/GX

POWER OPTIMIZER WITH A SERVICE OF THE WATER SYSTEM

TATAREK Sp. z o.o.
50-559 Wrocław , Świeradowska 75
ph. (71) 367-21-67, 373-14-88
fax: 373-14-58
VATIN 899-278-63-72

Bank account: SANTANDER BANK POLSKA S.A. Wrocław 6910901522-0000-0000-5201-9335

www.tatarek.com.pl, e-mail: tatarek@tatarek.com.pl

TATAREK®

TATAREK®

Table of Contents

- 1. Basic technical parameters 3
- 2. General advantages of using the RT-18 VETRO optimizer 3
- 3. Principle of operation 3
- 4. Software versions 4
- 5. Information on the installation of the VETRO OM / GX RT-18 optimizer 7
- 5.1 Recommended cables for connecting peripheral devices to the optimizer 7
- 5.2 Mounting recommendations 9
- 5.3 Connection diagram 10
- 6. Alarms 12
- 7. Combustion control 13
- 7.1 Combustion temperature sensor 13
- 7.2 Operation phases of the optimizer 13
- 7.3 Limitation of the maximum combustion temperature 15
- 7.4 Air damper 15
- 8. Control of the AIR system 16
- 9. Control of the HYDRAULIC system 17
- 9.1 System with the buffer pump 18
- 9.2 Laddomat system 19
- 9.3 System with the transfer of heat directly to the central heating installation 20
- 9.4 System MIX - combining the feed of the storage mass with the water base operation 21
- 10. Control of additional circuits 22
- 10.1 Mechanical ventilation or GC draught generator 22
- 10.2 The NW water capping/water base flap 23
- 10.3 The AC storage mass flap (Moritz one) 23
- 11. How to operate the optimizer 25
- 11.1 Start screen 26
- 11.2 Operating screens 27
- 11.3 System settings 28
- 11.3.1 Informations 28
- 11.3.2 Entering the password 28
- 11.3.3 Setting the date 28
- 11.3.4 Setting the time 29
- 11.3.5 Setting of sound signalling 29
- 11.3.6 Switching off the touch screen for cleaning the "glass" 29
- 11.3.7 Brightness and duration of the display backlight 29
- 11.4 Screens informing about optimizer's work 30
- 11.5 Setting the parameters 31
- 11.5.1 Parameter change in the form of a number 31
- 11.5.2 Change of the parameter in the form of choice of possibilities 31
- 12. MENU tables of setting the parameters 32-38
- 13. Passwords 38
- 14. Updating the optimizer software 38
- 15. CE Conformity Declaration 41
- 16. Warranty rules 42
- 17. Warranty card 43

17. Warranty card

Admission date	Realization date	Signature	Remarks

16. WARRANTY RULES

1. Warranty is valid [24] months from the date of sale.
2. The manufacturer does not take responsibility for any mechanical damages made by the user.
3. MAKING REPAIRS OR MODIFYING THE DEVICE BY THE USER IS FORBIDDEN AND CAUSES WARRANTY CANCELLATION.
4. Warranty card is valid only with date of sale, seller's signature and stamp.
5. Warranty and after-warranty repairs should be done only by the manufacturer, damaged devices should be sent to the manufacturer in order to make all repairs needed.
6. Warranty protection is valid in the EU.
7. Warranty does not exclude, not restrict and not suspend buyer's rights coming from the incompatibility of the article with the agreement (Laws Journal No. 141 Pos. 1176)

WARNING !

ANY MODIFICATION OF THE DEVICE MADE BY THE USER CAN BE A CAUSE OF SAFETY CONDITIONS DETERIORATION AND CAN EXPOSE THE USER TO ELECTRIC SHOCK OR DAMAGE DEVICES SUPPLIED.

Connecting cable of the device may be replaced only by the manufacturer or his authorized service locations.

WARNING!

1. The manufacturer does not take the responsibility for damage caused by atmospheric discharge
2. and overvoltage in the mains.
3. Burnt fuses are not subject to warranty replacement.

Date of sale

Seller's signature and stamp



TATAREK Sp. z o.o.

50-559 Wrocław, Świeradowska 75

ph. (71) 367-21-67, 373-14-88

fax: 373-14-58

VATIN 899-278-63-72

Bank account : SANTANDER BANK POLSKA S.A. Wrocław 6910901522-0000-0000-5201-9335

www.tatarek.com.pl, e-mail: tatarek@tatarek.com.pl

1. Basic technical parameters

Power.	230V/50Hz
Auxiliary power.	Rechargeable battery 4,8V/60mAh
Power consumption without load.	5W
Maximum connection power.	500W
Operating conditions.	5±50°C, humidity 10÷80% no condensation
Housing protection class.	IP41
Fuse.	6,3A/250V
Number of relay outputs.	1* max250W/230V/50Hz
Auxiliary relay.	1* max100W/230V/50Hz
Number of triac outputs to control pumps.	4* max150W/230V/50Hz
Number of outputs to control the air damper.	2 * 5V/500mA/DC
Number of sensors of flue gas temperature.	2 * Thermocouple type K (up to +1200°C depending on the design) Measurement precision 5°C, resolution 1°C
Number of sensors of water temperature (or bistable inputs).	8 * NTC 2.2k (0...+120°C) Measurement precision 2°C, resolution 0,1°C
Open-door sensor.	REED-RELAY or mechanical one

2. General advantages of using the RT-18 VETRO optimizer

- * High comfort of use of heating systems supplied from stove inserts or tile stoves

The user, apart from firing up and providing fuel - does not interfere in the operation of the stove and heating system !!!

- * Ensure very high combustion purity
- * Optimal use of heat gained in the burning process
- * Extending the life of the furnace
- * Protection of the operation of the furnace and the entire heating system cooperating with it (protection against overheating, freezing or carbon monoxide)
- * It allows you to protect the furnace against the use of the wrong fuel !!!

3. Principle of operation

Using the **PP1** intake air damper (smoothly regulating the air supply in the range of 0-100%), the optimizer controls the combustion process and maintains the heat. Thanks to the air dosing according to the combustion curve and the appropriate leading algorithms, the optimizer ensures the optimum course of the combustion process in terms of the most efficient use of fuel while maintaining the highest possible combustion purity. When the furnace door is closed, it completely supervises the combustion process and closes the air supply after reaching the embers in the furnace - at the same time providing information about the need to add fuel. This model is also able to provide automatic heat transfer into storage modules, or in case of operating the water jacket / water base - transferring hot water to the heat buffer and supplying the central heating system with it. It is also possible to automatically activate / deactivate the operation of mechanical ventilation or draught generator of flue gases. In addition, it also has its own small emergency power source - interruptions to the mains supply for up to 8 seconds do not interfere with its operation and give time for switching on the optional emergency buffer power supply. If the interruption in the power supply lasts longer, then before the optimizer is turned off, the air damper will be opened for safe burning out of the fuel. The value of the air damper opening angle can be set individually in the parameter setting (the **P.Err** parameter) in the range from 20-100%.

The optimizer allows you to choose one of the three power programs of the stove insert operation, depending on the user's needs.

4. Software versions

The **RT-18 VETRO OM / GX** optimizer has the capability to choose the program of operation selected in terms of operating the proper heating system cooperating with the furnace.

There are two program versions to choose from which are equivalent to the following TATAREK optimizers :

OM - Power Optimizer

GX / OM- Hybrid of OM and water base / water jacket

The choice of the right software version depends on the type, construction and function of the heating system supplied by the furnace. Properly selected software allows for optimum use of heat, while maintaining the largest possible economy and ecology of the combustion process.

The default version of the optimizer software is OM (Power Optimizer)

15. CE Conformity Declaration

CE CONFORMITY DECLARATION

Ref. No. 60.RT18.2018/1

We, **TATAREK Sp. z o.o.**

75 Swieradowska St. , 50-559 Wroclaw

declare under our sole responsibility that
the product: Power Optimizer

model: **RT-18 VETRO OM/GX**

is in conformity with the basic requirements included in Directive EMC 2004/108/WE of 15.12.2004 (the electromagnetic compatibility law of 13.04.07) and Directive LVD 2006/95/WE of 21.08.07 (Laws Journal of 2007 No. 155 pos. 1098) regarding the requirements for electric devices.

To the conformity evaluation the following harmonized standards were used:

PN-EN 60730-2-1: 2002 - Automatic electric regulators for house usage and the like. Part 2-1: Specific requirements regarding electric regulators for electric house devices

PN-EN 60730-1: 2012 - Automatic electric regulators for house usage and the like.
Part 1: General requirements.

PN-EN 55022: 2011 - Electromagnetic compatibility (EMC)- IT devices
Characteristics of radioelectric noises. Acceptable levels and measurement methods

Electronic Engineering Plant TATAREK Sp. z o.o.

has initiated management system and complies with the following standard :

ISO9001: 2000 CERTIFICATE No. 133/2004 of 01.2004

Polish Foreign Trade Chamber

The last two digits of the year in which the CE marking was affixed: 18

Place of issue:
Wroclaw

Date of issue:
08.2018

Manufacturer representative:

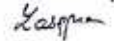
Mirosław Zasepa

Position:
Electronic Designer

8. Lack of this screen means that the USB memory is not recognized. In this case, repeat the steps from the beginning and if it does not help then try another USB stick.
9. The update may take several minutes.
10. Correctly completed update is signalled by displaying the message:
 - **Prg: OK**
 - **Img: OK**
 - **Dev: OK**
 - **POWER OFF & REMOVE USB**
11. Turn off the power, disconnect the "pendrive" memory and turn on the power again. The optimizer will start with updated software!
12. Another message means a failure and signals the probable cause of the error.

! During the update the optimizer checks the conformity of the hardware and software version - the incompatibility is signalled as a configuration error.

Division of software versions in terms of their use:

OM - dedicated software for stove inserts and tile furnaces that deal with large storage systems composed of storage fittings. It will push the combustion curve up in the high temperature range ensuring the transfer of as much heat as possible to the storage mass, while guaranteeing clean combustion and thus the cleanness of the heating channels.

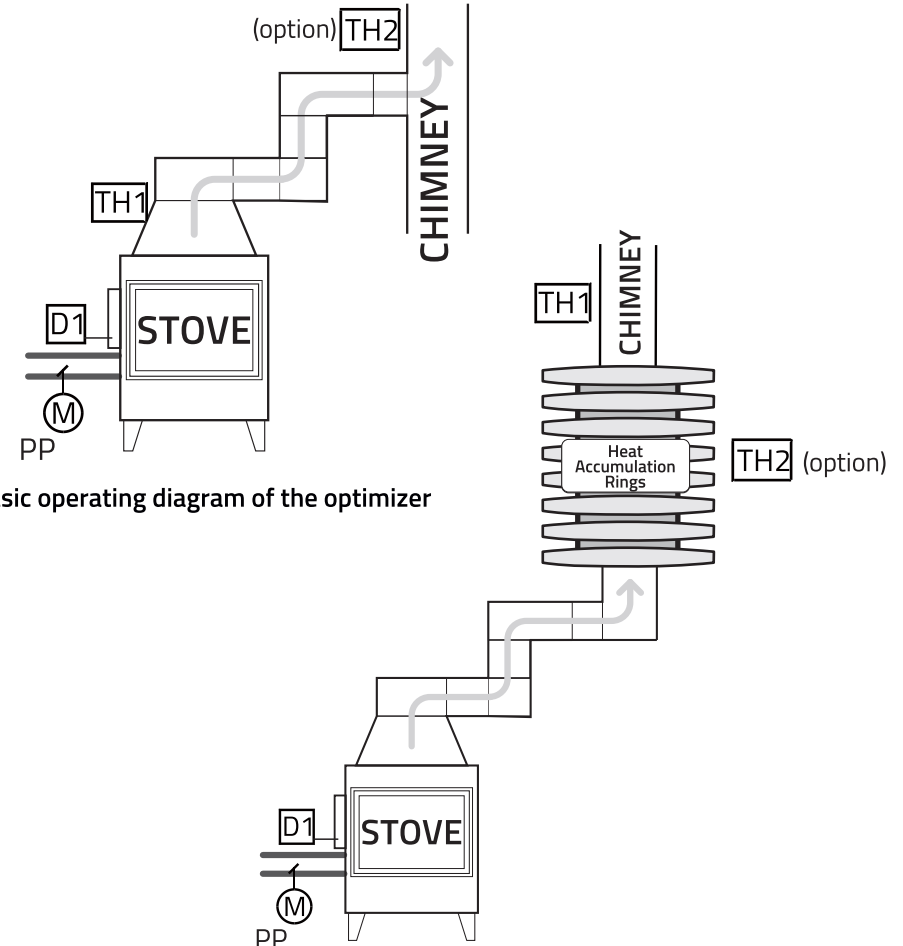

Fig. 1 Basic operating diagram of the optimizer

Fig.1a Example of a optimizer operation system with low accumulation mass

- TH1- Combustion temperature sensor
- TH2- Temperature sensor of flue gas (option)
- for the RT-08 OM GRAFIK II controller it's standard!
- D1- Open-door sensor (option)
- PP- Controlled air damper

GX/OM – dedicated software for mixed systems, using both storage masses and water bases/caps. It allows for efficient management of the heat in the water base or water jacket in terms of supplying the heat buffer or directly the central heating system CO and alternatively combining this function with the feed of the heat storage module (by controlling the drive of the chimney flap directing the flue gas to the heat storage module or to the water base).

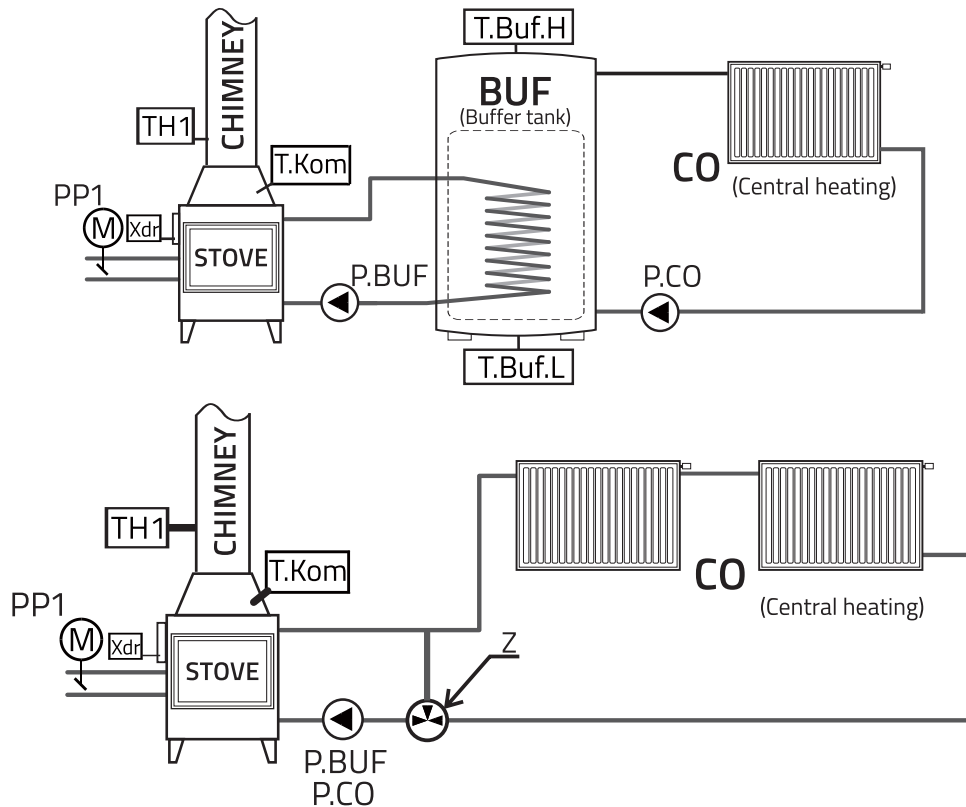
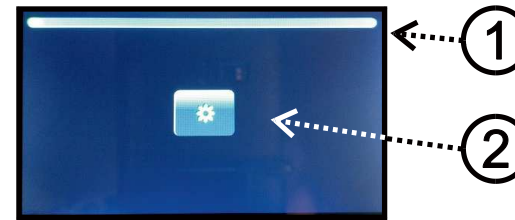

Fig.2. Examples of the optimizer operation diagrams with the water jacket / water base support.

- PP1- Air damper
- P.BUF- Pump or Laddomat for feeding the buffer
- P.CO- Circulating pump
- TH1- Combustion temperature sensor
- T.Kom- Water temperature sensor of the stove
- T.Buf.H- Buffer upper part temperature sensor
- T.Buf.L- Buffer lower part temperature sensor
- Xdr- Open-door sensor
- Z- Bimetallic mixing valve ensuring the return of water to the stove at a constant temperature level.

3. There may be three different software versions in the root directory of the USB memory - subdirectories "RT18_0", "RT18_1" or "RT18_2". With the optimizer powered off, connect the USB memory to the connector on the operating panel (see chapter 6).
4. Turn on the optimizer power supply. A boot screen should appear on the operational panel:



- (1) Progress bar (elapsed time to start)
- (2) Calling up the service screen.

5. After a moment, the optimizer reads in the "pendrive" memory and automatically switches to the USB function screen (7)
6. If there is a lot of other data in the "pendrive" memory, the progress bar may end and the optimizer will restart. To prevent this, you can manually call up USB functions - ie call the service screen (2) up and activate USB functions (1)

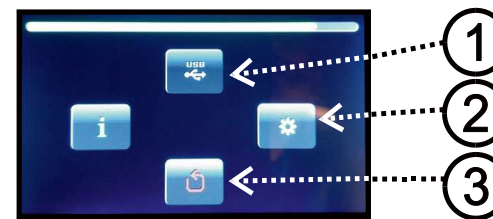

- (1) USB functions
- (2) Features reserved for the service
- (3) Restart of the optimizer

7. On the USB functions screen, touch the field (4) and initiate the update from the "RT18_0" directory (or (5) / (6) for the "RT18_1" / "RT18_2" directory respectively)

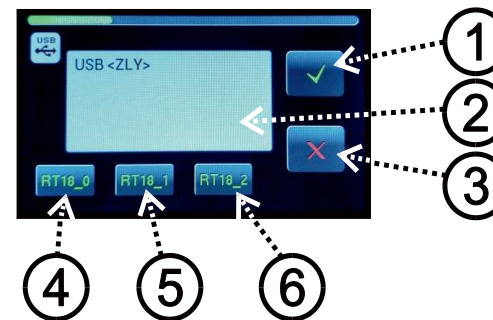

- (1) Renewing the progress bar time
- (2) Information field
- (3) Exit the USB functions screen and restart the optimizer
- (4) Start updating with data in the subdirectory „RT18_0“
- (5) Start updating with data located in the subdirectory „RT18_1“
- (6) Start updating with data located in the subdirectory „RT18_2“

012 Test of INPUTS

Readout of input signals. of the RT181 executive module

013 Test of OUTPUTS

Ability to enable / disable outputs of the RT181 executive module

014 Password change**015 Restoring default settings****13. Passwords**

The password (4-digit PIN) is used to block changes of some „strategic“ parameters. You can access them after entering the correct password (see system settings - entering the password). The password is valid for 30 minutes and after this time the optimizer will automatically invalidate it - if necessary, you must enter it again. The wrong password resets the counter to 30 minutes and locks the password mechanism. Wait for 1 minute before you can retry.

! By default, the optimizer has the password "0000" implemented, which means the password mechanism is turned off.

! The password can be changed by calling MENU "014 Password change". Of course, in case of enabled passwords, in order to change the password, first enter the current password from the system settings.

! Changing the password to "0000" disables the password mechanism again.

14. Updating the optimizer software

! The function is intended for the service and trained users. Improper update of the software can lead to blocking the optimizer.

The optimizer is equipped with a connector to connect an external USB flash drive (pendrive) and modification (update) function of the software. To use it, do the following:

1. Prepare a typical USB memory device designed for work in PCs, under the control of the WINDOWS system (with the FAT16 or FAT32 file system).
2. Copy the sub-folder "RT18_0" received from the website into the root directory of the USB stick with three files with the extension "x" (P18.x / Dev.x / Img.x).

Manufacturers of stove inserts / furnaces and complex heating systems cooperating with them may have individual versions of the software intended for particular technical solutions, and in this case it is recommended to use software dedicated by the manufacturer !!!

5. Information on the installation of the VETRO OM / GX RT-18 optimizer

For correct mounting of the device you will need:

- ✘ Screwdriver with 2.5 mm electrical insulation with a flat end
- ✘ Screwdriver with 2.5 mm electrical insulation and no. 0 cross end

The following can also be useful:

- ✘ Pliers with thin ends and electrical insulation of handles

Pay special attention to careful installation of wires in the RT181 executive module, passing them through the supplied glands, which will ensure the overall tightness of the module and protect it against the influence of moisture and pollution !!! Ensuring tightness of the module housing during assembly allows for safe operation of the optimizer and significantly extends its life !!!

5.1 Recommended cables for connecting peripheral devices to the optimizer

- ✘ Power cord: 3 x 0.75 mm² stranded wire
- ✘ Air damper cable: 3 x 0.5 mm², default length: 3 m (cable extension is not recommended)
- ✘ Flap servomotor / pomp / 230V Laddomat cable: 3 x 0.75 mm² stranded wire
- ✘ Connecting cable for contact CONTROL: 2 x 0.5 mm² (unlimited length)
- ✘ Thermocouple sensor (type K): diameter of the jacket - 3.2 mm, cable length - 3 m
- ✘ NTC water sensor 2.2k: 2 x 0.5 mm², length 3 m (max. extension up to 25 m) up to 10 m with no difference in the temperature readout

Extending the thermocouple's cable with any wire is unacceptable due to the specificity of its construction, and if it proves necessary - it is necessary to purchase a dedicated extension cable with a connector of the right parameters!

Depending on the selected equipment version, the factory set includes the following things:

RT-18 VETRO OM:

- RT181 executive module
- RT18 operator panel with assembly box
- 5-meter connecting cable of the operator panel
- Flue gas temperature sensor (K type thermocouple)
- Cold air damper with the seal and power cord

RT-18 VETRO GX / OM:

- RT181 executive module
- RT18 operator panel with assembly box
- 5-meter connecting cable of the operator panel
- Flue gas temperature sensor (K type thermocouple)
- NTC 2.2k water temperature sensor with temperature reinforcement
- 2 x NTC 2.2k water temperature sensor of the buffer
- Cold air damper with the seal and power cord

Optionally, it is possible to order additional equipment for the optimizer:

- Flue gas temperature sensors
- Water temperature sensors
- Open-door sensor (REED RELAY)
- Chimney flap drive with the BELIMO assembly set
- Carbon monoxide detector
- Ceramic shield casing of the flue gas sensor

011 Configuration

12 *H)	V.X /Type of open-door sensor	1..2	1 *F)		=1 Normally closed open-door sensor (at closed door, X terminals open) or the lack of a door sensor =2 Normally open open-door sensor (at closed door, X terminals shorted)
91	M.NW	OFF(0)/ ON(1)	ON(1)		NW (water base/cap) control. Temporary stop / start of the water base. The same effect can be obtained from the contextual MENU - the water base icon.
92 *H)	V.LAD	OFF(0)/ ON(1)	OFF(0)		The Laddomat system instead of the BUF pump
93 *H)	V.GC /Operating mode of ventilation	1..2	2 *F)		M.GC output: = 1 ventilation = 2 draught generator
94 *H)	V.NW /Operating mode of water base	0..2	0 *F)		M.NW output: = 0 Lack of the water base (air stove) = 1,2 Control variant of NW (See ch.10.2 "NW Water Base Flap")
95 *H)	V.AC /Operating mode of AC	1..4	1 *F)		M.AC output: =1,2,3,4 Control variant of AC See ch. 10.3 „Storage Mass Flap (Moritz one)“
96 *H)	V.STER	0..1	0 *F)		CONTROL relay = 0 The relay is switched on when ALARM is on = 1 The relay is switched on when the NW (water base) temperature is above T.STER
97 *H)	T.STER	5...1250 °C	60 °C		Control temperature. Temp. threshold for switching on the CONTROL relay if it is not set to ALARM
98 *H)	MAN	OFF(0)/ ON(1)	ON(0) *F)		Permission for MAN manual operation

007 Hysteresis of the water base (NW)

72 *H)	TSh.NW /Flue gas temp. M.NW off	10...1250 °C	50 °C		Hysteresis of the flue gas temperature of on / off of the NW (water base) flap drive. The flap will direct the flue gas to the chimney when the flue gas temperature will decrease relative to the threshold by hysteresis. (too low flue gas temperature for active NW operation)
74 *H)	Th.NW /Water temp. M.NW off	10...100 °C	20 °C		Increasing the water temperature in the water base above this value will cause the NW flap drive to direct the flue gas to the chimney (the water base/cap stops heating the water)
64 *H)	th.NW /Time hysteresis M.NW	0...5 min	0 min		The time hysteresis of on / off of the actuator of the water base flap M.NW. Minimum operation / stop time of M.NW to prevent frequent changes.

008 Hysteresis of the buffer (BF)

60	TSh.BF / Flue gas temp. hysteresis P.BUF	10...100 °C	20 °C		Hysteresis of the flue gas temperature of on / off of the P.BUF pump. P.BUF will turn off when the flue gas temperature decreases relative to the threshold value by the hysteresis value. (too low flue gas temperature for P.BUF work)
61	Th.BF /Temp. hysteresis P.BUF	1...10 °C	3 °C		Temperature hysteresis of on / off of the P.BUF buffer pump. P.BUF will turn off when the water temperature decreases relative to the threshold by the hysteresis value. (too low water temperature for P.BUF work)
62	th.BF /Time hysteresis P.BUF	0...5 min	0 min		Time hysteresis of on / off of the P.BUF buffer pump. Minimum time of work / pause of P.BUF to prevent constant operation ON/OFF

009 Hysteresis of the circulating pump (CO)

67	Th.CO /Temp hysteresis. P.CO	1...10 °C	3 °C		Temperature hysteresis of on / off of the P.CO circulating pump. P.CO will turn off when the temperature decreases relative to the threshold by the hysteresis value. (too low water temperature for P. CO work)
68	th.CO /Time hysteresis P.CO	0...5min	0 min		Time hysteresis of on / off of the circulating pump P.CO. Minimum time of work / pause of P.CO to prevent constant operation ON/OFF

010 Alarms

17 *H)	T.KOM.max /Max. water temp. in stove	10...100 °C	95 °C		Exceeding this water temperature in the stove will trigger the alarm
18 *H)	T.BUF.max / Max. water temp. in buffer	10...100 °C	95 °C		Exceeding this water temperature in the buffer will trigger the alarm

5.2 Mounting recommendations

Installation of the optimizer should be carried out with due care, with particular regard to safety rules (electrical equipment), and caution when screwing down the contacts in the optimizer connection boxes during the assembly of the wires, so that they will not be mechanically damaged due to the use of excessive force.

The THERMOCOUPLE SENSOR has a laser-marked marker on the outer casing - indicating the maximum mounting depth in the element in which the temperature will be measured !!!

The THERMOCOUPLE SENSOR can not be exposed to direct flames !

If it is feared that the flames can reach the sensor's measuring top - it is required to use an additional sensor ceramic shield casing (option), protecting it against burnout !!!

Improper sensor assembly can lead to premature wear-out !!!

IMPORTANT !

Before installing the optimizer, make sure that there is a secure supply of power to the building, whereas if the building is temporarily supplied by the so-called building voltage, remember before switching it to the correct voltage to disconnect the voltage wires from the optimizer !!!

THE OPTIMIZER MUST BE ABSOLUTELY CONNECTED TO THE EARTHING CABLE !!!

- The control panel should be located in the immediate vicinity of the stove, so as to ensure a constant preview of the installation's operation parameters and to provide information as soon as possible in the event of any failure.
- In order to protect the optimizer against excessive temperature existing near the stove insert - the control panel should not be mounted in the stove casing alone, except for places specially prepared for this purpose in terms of temperature protection.
- Too high ambient temperature of the optimizer may over time adversely affect the life of some components and thus lead to premature wear-out.
- The inlet air damper should not be installed closer than 1 m from the air intake to the intake duct, due to the protection against too low temperature. Its position during work is arbitrary - it can work in any plane without any contraindications in this matter.
- Before mounting the whole equipment, it is necessary to provide access to **the inspection openings in the stove casing**, which will ensure simple and uncomplicated access to the peripheral equipment of the optimizer: air dampers (PP1, PP2) and temperature sensors (TH1, TH2, Tkom). This will allow you to periodically check the cleanness of the air damper wing, as well as provide trouble-free access to temperature sensors in case of their failure.

5.3 Connection diagram

The VETRO RT-18 optimizer is a modular device and consists of two modules communicating via a connection cable:

- **OPERATOR PANEL "RT18"** - gives all information related to the operation of the furnace and the heating system, allowing to choose the appropriate operating mode or change of individual operation parameters
- **EXECUTIVE MODULE "RT181"** - main control unit to which all incoming (eg sensors) and outgoing signals (eg power cables for peripheral devices) required by the heating system are connected.

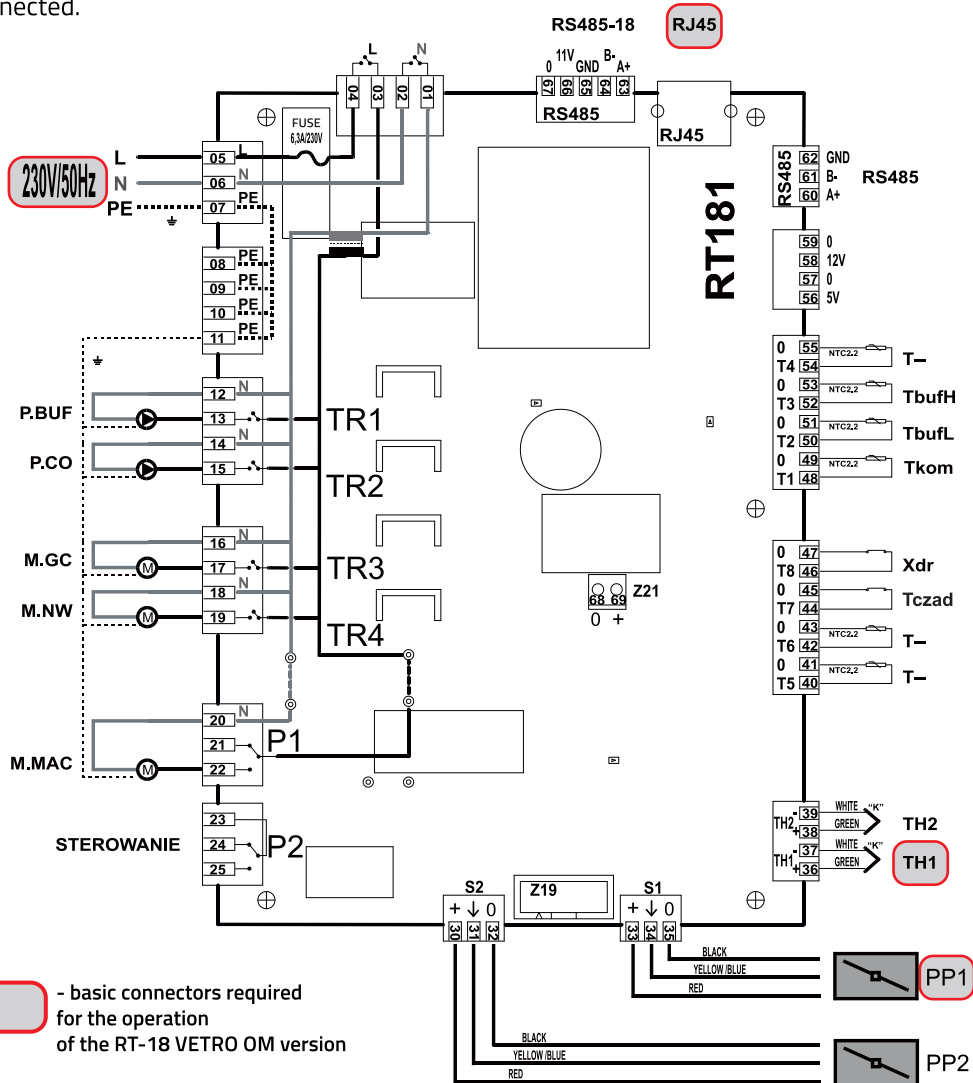

Fig.3. Connection of the RT181 executive module

002 Water base (NW)

71	TS.NW /Combustion temp. M.NW on	10...1250 °C	150 °C		Increasing of the flue gas temperature above this value will cause the NW (water base) flap drive to direct the flue gas to heat the water. (flue gas temperature high enough for active NW operation (water base/cap operation)
73	T.NW /Water temp. M.NW on	10...100 °C	65 °C		Minimum water temperature of the water base/cap which will cause the NW (water base) flap drive to direct the flue gas to the water exchanger . (water temperature of the water base too low - turn on heating by active operation of NW (water base/cap))

003 Storage mass (AC)

75	TS.AC /Start temp. M.AC	10...1250 °C	380 °C		Flue gas temp. which switches the AC flap drive (activation of the heat storage block)
----	----------------------------	--------------	--------	--	--

004 Draught generator (GC)

70	t.GC /Start time M.GC	1...99 min	1 min		For ventilation - delay in switching on ventilation For the draught generator - operating time of the generator after closing the stove door (Setting to 99min switches on the GC to the end of the combustion cycle)
----	-----------------------------	------------	-------	--	--

005 Loading the buffer (BF)

50	TS.BF /Combustion temp. P.BUF on	0...1250 °C	80 °C		Minimum temp. of flue gas of the stove above which the P.BUF buffer pump can run. Setting the value "0" disables the influence of the flue gas temperature on the pump operation.
51	T.BF /Start temp. P.BUF	10...100 °C	45 °C		Minimum water temp. in the water exchanger of the stove above which the P.BUF buffer pump can run.
52	dT.BF /delta P.BUF	-10...10 °C	3 °C		The minimum difference between the temperature of the stove and the buffer necessary for the operation of the P.BUF buffer pump. Negative numbers are applicable for large buffers with one temperature sensor.

006 Circulating pump (CO)

66	T.CO /Start temp. P.CO	10...100 °C	40 °C		Water temperature of the upper part of the buffer above which the P.CO circulating pump is activated.
----	---------------------------	-------------	-------	--	---

001 Stove - Combustion**105 Setting the air damper**

25 *H)	P.Err	20...100 %	100 %		Degree of emergency opening of the air damper at power failure. At the default setting, the air damper opens completely (100%)
28 *H)	t.P	5...30 s	20s		Time between changes in the position of the air damper (air damper cycle). The optimizer sends a control signal to the air damper in the time unit specified by this parameter concerning the angle change of the air damper wing
27 *H)	t.MANO	0...30 min	5min		The control function of closing the air damper in MANUAL mode while combustion is in progress (i.e. the flue gas temperature exceeds <22> T.F? 45 ° C). After this time the air damper will be reset to 25% automatically. In this state, the air damper will close again once the combustion has finished (i.e. for a time <23> t.F? = 2min, the flue gas temperature will be below <22> T.F? = 45 ° C). Setting t.MANO = 0min blocks the control function

106 Settings for P1 / MIN

30/1 *H)	T.F3/1	50...1250 °C	250 °C		Temperature of the phase F3 at the power P1 / MIN
42/1 *H)	Pmax.F3/1	0...100 %	60 %		MAXimum degree of the air damper opening of the phase F3 at the power P1 / MIN
43/1 *H)	Pmin.F3/1	0...100 %	10 %		MINimum degree of the air damper opening of the phase F3 at the power P1 / MIN

107 Settings for P2 / MIDI

30/2 *H)	T.F3/2	50...1250 °C	300 °C		Temperature of the phase F3 at the power P2 / MIDI
42/2 *H)	Pmax.F3/2	0...100 %	65 %		MAXimum degree of the air damper opening of the phase F3 at the power P2 / MIDI
43/2 *H)	Pmin.F3/2	0...100 %	10 %		MINimum degree of the air damper opening of the phase F3 at the power P2 / MIDI

108 Settings for P3 / MAX

30/3 *H)	T.F3/3	50...1250 °C	350 °C		Temperature of the phase F3 at the power P3 / MAX
42/3 *H)	Pmax.F3/3	0...100 %	70 %		MAXimum degree of the air damper opening of the phase F3 at the power P3 / MAX
43/3 *H)	Pmin.F3/3	0...100 %	10 %		MINimum degree of the air damper opening of the phase F3 at the power P3 / MAX

INPUTS:

T4(54/55)
T3(52/53)
T2(50/51)
T1(48/49)
T8(46/47)

T-- Reserved
TbufH Buffer temperature sensor mounted in the upper zone
TbufL Buffer temperature sensor mounted in the lower zone
Tkom Temperature sensor of the water jacket / water base of the stove
Xdr Open-door sensor of the furnace:
-The normally open sensor used (when the door is closed, the "Xdr" terminals are shorted), set the configuration parameter <12>V.X=2.
- The normally closed sensor used (when the door is closed, the "Xdr" terminals are open), set the configuration parameter <12>V.X=1.
- If there is no door sensor, leave the "Xdr" terminals unconnected and set <12> V.X = 1 or short the "Xdr" terminals and set to <12> V.X = 2.

T7(44/45)
T6(42/43)
T5(40/41)
TH2(38/39)
TH1(36/37)
RS485(60-62)
RS485-18(63-67)
RJ45

Tczad Carbon monoxide detector
T-- Reserved
T-- Reserved
TH2 Flue gas temperature sensor at the chimney outlet (K-type thermocouple)
TH1 Combustion temperature sensor (K-type thermocouple)
Connector for other executive modules (option)
Connector for the RT18 operating panel (option)
Connector to the RT18 operating panel (standard computer cable RJ45 1:1 UTP5)

OUTPUTS:



TR1(12/13)
TR2(14/15)
TR3(16/17)
TR4(18/19)
P1(20/22)
P2(23-25)
S1(33-35)
S2(30-32)

P.BUF Buffer loading pump or Ladomat pump (230VAC, 250W max)
P.CO Circulating pump CO (230VAC, 250W max)
M.GC Draught generator fan GC (230VAC, 250W max)
M.NW Drive of the water base NW (230VAC, 250W max)
M.MAC Drive of the flap of the accumulation mass MAC (230VAC, 250W max)
Auxiliary relay CONTROL (free terminals, 230VAC max or 30VDC, 3A)
PP1 Electrically controlled TATAREK air damper (6VDC max)
PP2 Electrically controlled TATAREK air damper (6VDC max)- option DUO

! For the operation of the furnace, it is necessary to connect the **TH1** sensor (combustion temperature) and the **PP1** air damper, and in case of selecting the GX operating mode with the water base / water jacket to load the heat buffer- additionally the water sensors **Tkom / TbufH / TbufL**, and to directly feed the central heating CO - only the water sensor **Tkom** **!**

! By default, the optimizer is set as the AIR ONE RT-18 VETRO OM (<94> = 0) **!**

6. Alarms

The occurrence of an alarm situation causes the red indicator light  on the operator panel, acoustic signal (if the sound alarm option is enabled (see p.11.3.5) and the blinking icon  (see p.11.2). Touching the icon disables the alarm sound and displays additional information. The optimizer informs about the following alarm situations:

Alarm	Reaction of the optimizer
No communication with the RT181 executive module	* Operation blocked
Wrong (incompatible) version of the software in the RT181 executive module	* Operation blocked
Failure / lack of the TH1 combustion sensor	* Switch- off of the draught generator fan"M.GC" * Transition to the combustion phase "F?" (same as after turning on the power supply)
Exceeding of the MAX temperature of the TH1 combustion sensor	* Switch- off of the draught generator fan"M.GC" * Limiting of the opening of the air damper according to the parameter <21> P.Alarm

In addition, alarms reported if the stove is the water one, i.e. the parameter <94> N.NW is different than 0:

Alarm	Reaction of the optimizer
Failure / lack of the sensor Tkom (T1)	* Switch-on of the "P.BUF" pump (buffer loading or Laddomat pump) * Switch- off of the draught generator fan"M.GC" * Switch- off of the water base "M.NW" (flue gases bypass the water base)
Exceeding of MAX Tkom (T1)	* Switch-on of the "P.BUF" pump (buffer loading or Laddomat pump) * Switch- off of the draught generator fan"M.GC" * Switch- off of the water base "M.NW" (flue gases bypass the water base) * Transition to the combustion phase "F?" (same as after turning on the power supply)
Exceeding of the MAX buffer temperature (if the sensors for buffer temperature are connected)	* Switch-off of the "P.BUF" pump (buffer loading or Laddomat pump) * Switch-on of the circulating pump "P.CO" * Transition to the combustion phase "F?" (same as after turning on the power supply)
Freezing risk, Tkom (T1) below 4°C	* Switching on the "P.BUF" pump (loads the buffer or Laddomat pump)
Freezing risk, buffer temperature below 4°C (if the buffer temperature sensors are connected)	* Pump "P.BUF" activation (buffer loading pump or Laddomat pump) * Switching on the "P.CO" circulating pump

! The alarm can cause the relay CONTROL (P2) to be switched on according to the parameter setting <96> V.STER.

In the case of a water system it turn on, e.g. an additional solenoid valve, or in the case of an air system - an exhauster.

001 Stove - Combustion

101 Maximum values

NO.	NAME	RANGE	DEFAULT SETTING	SETTING	FUNCTION
20 *H)	T.Alarm	200...1300 °C	600 °C		Maximum stove temperature. When it is exceeded, an alarm will be activated and the air damper will close to the position determined by the next parameter <21> "P.Alarm". The temperature limitation hysteresis is 50°C. Setting the value to 1300 °C means that T.Alarm control is disabled.
21 *H)	P.Alarm	5...50 %	10 %		The degree of the air damper opening when the temperature exceeds the maximum value .

102 Combustion restart

23 *H)	T.F?	10...1250 °C	45 °C		Restart temperature. If after switching on the optimizer, the temperature of the stove is higher than <23> T.F? , then there will be an automatic start, i.e. going to F1.
24 *H)	t.F?	1...10 min	1min		Restart time. If after switching on the optimizer, the temperature of the stove is below <23> T.F? it is during this time that the optimizer waits with the decision to go to the standby phase F0

103 Firing-up

22 *H)	t.F1	1...30 min	1min		Delay of regulation start (F1 phase duration)
26 *H)	T.F2	30...1250 °C	250 °C		Temperature of ending the phase F2 and starting F3 . Its reaching means a positive ending of the firing-up phase.

104 Burning

32 *H)	dT.F3	10...200 °C	25 °C		Maximum temperature rise in the phase F3
34 *H)	dT.F3-F4	-10...-300 °C	-30 °C		Temperature drop in F3 signifying the start of the phase F4
36 *H)	t.F4	1...10 min	2 min		Duration of the condition "dT.F3 -F4" to complete F3 and go to F4
38 *H)	T.F5	50...1250 °C	150 °C		Start temperature of the phase F5
39 *H)	t.F5	1...60 min	5 min		Duration of the phase F5
40 *H)	t.F6	0...10 min	1 min		Duration of the phase F5. Scavenge time. Air damper opening and flue gas burnout.
42 *H)	P.F5	0...100 %	5 %		Air damper opening degree of the phase F5

12. MENU tables of setting the parameters

NO.	NAME	RANGE	DEFAULT SETTING	SETTING	FUNCTION
-----	------	-------	-----------------	---------	----------

! The parameter number (**NO**) has an auxiliary role - it is used to uniquely identify the name, e.g. for different language versions.

! The following rules for naming parameters were adopted:

T	temperature (temp.)
TS	temperature of flue gas
Th	temperature hysteresis
TSh	hysteresis of flue gas temperature
dT	temperature difference
t	time
th	time hysteresis
P	air damper setting
V	configuration

! Parameters whose default value is marked with * **F** do not change after performing the function "**015 Restoring default settings**"; in order not to change essential configuration settings. Any changes should be done individually!

! Parameters whose number is marked with * **H** require a password to change the value.

! Setting the stove to the air operating mode (i.e. with the water base/cap switched off, <94> = 0) causes that the water parameters are disabled and their change is blocked)

7. Combustion control

7.1 Combustion temperature sensor

The basic temperature sensor **TH1** supervising the combustion process is a K-type thermocouple, which has a temperature measurement range 0-1200 °C. The sensor is mounted either in the stove socket designed for that purpose by the furnace manufacturer or in the flue pipe above the combustion chamber.

Optionally, the second flue gas temperature sensor **TH2** can be used, which allows only to monitor the temperature of the flue gases at any place in the system (eg flue gas temperature at the exit behind the storage mass, or the temperature of the storage mass itself).

! If the flue gas sensor is exposed to direct flames - it is required to use a ceramic shield casing (optional) to protect it against burnout !

7.2 Operation phases of the optimizer



The optimizer controls the combustion process in the following cycle:

- ***F0**- **Stand-by phase**. The optimizer is waiting for the signal to start burning, i.e. opening the door. In the F0 state, the air damper is closed.
- ***F?**- **Transition phase** after power-on. The optimizer opens the air damper and checks the temperature of the stove. If the furnace is on fire (the temperature of the stove is higher than <22> **T.F? = 45 °C**), it automatically starts the burning cycle by going to the **F1 phase**. If the temperature is lower, the optimizer waits for the time <23> **t.F? = 2 minutes** checking if the temperature will not increase. If not, it closes the air damper and sets **F0**.
- ***Fx**- **Opening of the door**. Opening of the air damper to avoid smoking. Closing of the door will start the burning cycle. In case the optimizer does not have an automatic open-door sensor **Xdr**- each time one feeds the fuel, one must manually activate the burning process with the key  on the main screen menu of the optimizer (see p. 11.4)
- ***F1**- **Start phase**. After loading the wood and lighting it, close the stove door. This is a signal to the optimizer that the combustion cycle has started. The air damper is open. For the time <22> **t.F1 = 3 minutes**, the optimizer waits for the kindling to burn up and lights the wood and then goes to **F2**. From **F2**, the next phases depend on the combustion temperature.
- ***F2**- **Firing-up phase**. After heating the chimney and reaching the limit temperature <26> **T.F2 = 250 °C** is considered that the firing-up process has ended. The transition takes place to **F3**
- ***F3**- **Burning phase**. Stabilization of the combustion temperature depending on the selected stove power.
- ***F4**- **The phase of afterburning and lowering the temperature**. The air damper is being gradually closed to the value <44> **P.F5 = 5%**. The afterburning phase ends when the temperature is reduced to <38> **T.F5 = 150 °C**.

- *F5- **Embers phase.** Signaling the need for a refuel if combustion is to be continued. The embers phase lasts $<39> t.F5 = 10 \text{ min}$
- *F6- **Flue gas removal phase.** The air damper opens for $<40> t.F6 = 1 \text{ min}$ and then its closure and transition to the standby phase F0.

! The optimizer can control the stove without the open-door sensor. In this case, the context menu options of the operating screens of the optimizer are used (see p.7.4).

! The optimizer can control the stove without the open-door sensor. In this case, the touch field  is used on the optimizer's operating screen (see p.11.4).

! It is possible to conditionally stop the combustion process with the key  (also signalled by the change of the colour of the backlight of the signal light  from white to green). In the case, however, if the optimizer assesses that it collides in terms of safety with service of the furnace and installation - the burning process will be automatically restored !

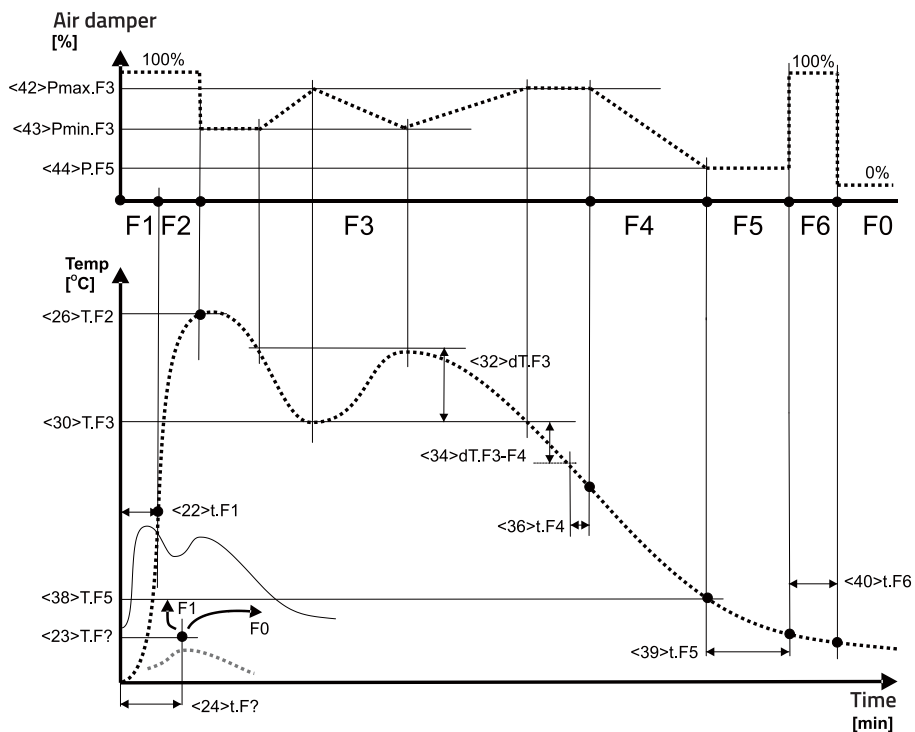

The most important parameters related to the combustion process are on the following graph:

Combustion curve RT18om with selected regulation parameters



! The following convention of parameters is adopted $<23> T.F? = 45 \text{ }^\circ\text{C}$, meaning that the parameter No. $<23>$ named "T.F?" (Restart temperature after power-on) is set to $45 \text{ }^\circ\text{C}$.

11.5 Setting the parameters

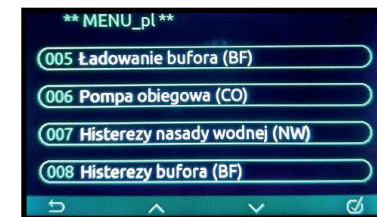

Parameters are grouped in the form of MENU. Moving around the menu (screen change) follows after touching  / . To change the selected parameter, tap its field.

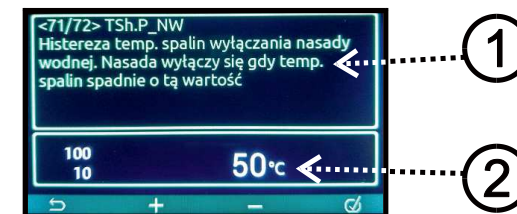

11.5.1 Parameter change in the form of a number

- (1) Parameter description field
- (2) Actual value (on the left - limit values).



The parameter value should be changed with  / . Touching  takes you to the next parameter from the given group.

Touching  bypasses setting other parameters of the given group (return to previous / up-level screen). After making changes, the data is automatically stored in the optimizer's memory.

11.5.2 Change of the parameter in the form of choice of possibilities

- (1) Check box

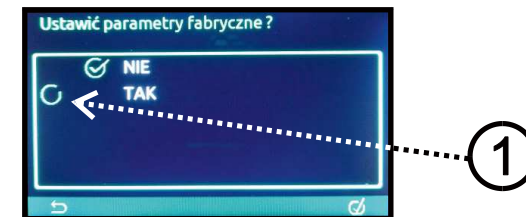

The selected field should be touched and the selection mark will be set. Touching takes  you to the next parameter from the given group.

Touching  bypasses setting other parameters of the given group (return to previous / up-level screen)

11.4 Screens informing about optimizer's work (touch fields << and >>)

Base screen:



- (1) Consecutive combustion phases in graphical form
- (2) Air damper opening
- (3) Combustion temperature (Th1)
- (4) Power set to P1 / MIN, P2 / MIDI or P3 / MAX

Combustion curve screen:

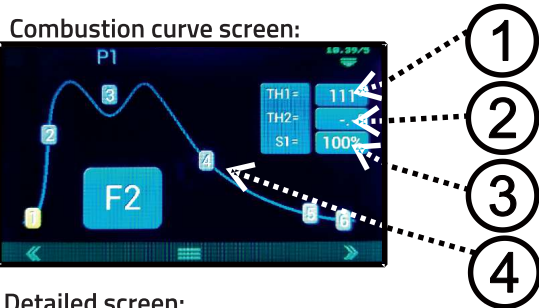
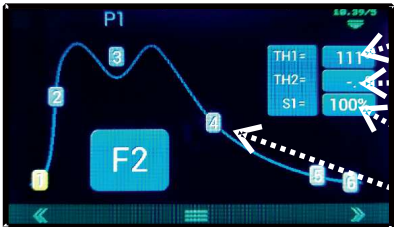

- (1) Combustion temperature (TH1)
- (2) The temperature at the outlet (TH2/option)
- (3) Air damper opening
- (4) Combustion curve with phase numbers

Detailed screen:

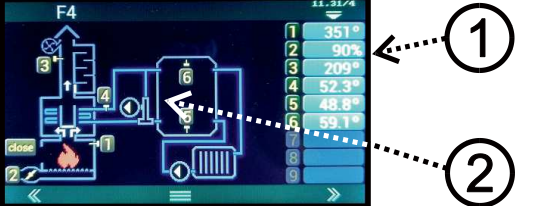
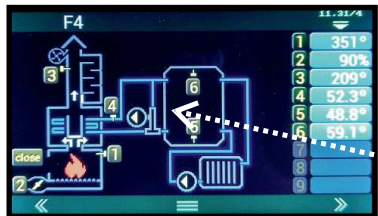

- (1) Indications of sensors at specific points in the diagram
- (2) Scheme of combustion and hydraulics

Calling up the context-sensitive MENU allows you to do the following:

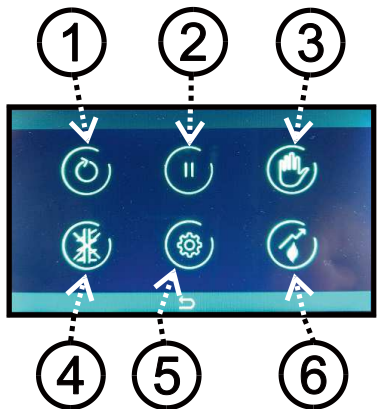

- (1) Manual start of the combustion cycle (if there is no open-door sensor)
- (2) Conditional combustion stop (only possible during the firing-up phase)
- (3) Start / Stop of manual operation
- (4) Temporary stopping / starting of the water-base
- (5) Calling up the parameter setting menu
- (6) Combustion history in the form of a TH1 / TH2 temperature diagram

7.3 Limitation of the maximum combustion temperature

For stove inserts, whose design requires limiting the maximum combustion temperature, it is possible to program the limit <20> dT.Alarm. Exceeding the allowable temperature will result in closing the air damper to <21> P.Alarm = 10% and activating the alarm signaling. The alarm will be turned off and the air damper will return to normal operation when the temperature drops again.

! The temperature limitation hysteresis is 50°C. The air damper is being gradually closed when the combustion temperature is lower than the alarm temperature by less than 50°C. The alarm will be activated when <20> T.Alarm is exceeded. The alarm will be cancelled and the normal operation will be restored when the temperature drops below Alarm-50°C.

7.4 Air damper

The air damper is mounted on the supply inlet of cold air to the combustion chamber. The position of the air damper wing is calculated by the optimizer depending on the course of the combustion process. The main air damper regulating the burning process is connected to the contact PP1. The PP2 contact is designed to operate an additional air damper dedicated to the furnaces operating in the DUO mode (primary / secondary air).



When using the completely sealed air dampers, it is not allowed to control any operation of the chimney flap (chimney damper), used to change the diameter of the main flue pipe !!! If the furnace is equipped with this type of damper - when using a optimizer which can control an intake air damper - the chimney damper should be either removed or be permanently in the fully open position !!!

! The optimizer displays the air damper position in %, where 0% means closure and 100% full opening. The actual air damper position may be different for a while because the drive updates the position in 5-20 second cycles (change of the air damper response time - parameter <28> t.P.).

The reduced reaction time (5 sec) is used for installations with increased chimney draught, which protects the furnace against too high flame stoking and ensures a smooth combustion process. The standard setting is 20 seconds and it is the optimum value for all furnaces, taking into account the chimney draught and the correct construction of flue ducts.

! In case of a power failure, the combustion process is not controlled. In order to prevent the possibility of increasing the concentration of CO (poisonous gas) in case of incomplete combustion before reaching the embers phase, the optimizer is equipped with its own backup power source - power outages up to 8 seconds do not interfere with its operation (backup power can be activated at this time), if the break lasts longer then before the optimizer turns off, the air damper is reset to within 20 ... 100% according to the parameter setting <25> P.Err. In this mode, the user only has the option of manually adjusting the air damper position angle by means of the additional lever mounted on its casing.

8. Control of the AIR system

As a standard, the optimizer is set to the OM program mode, which allows the use of stove inserts and classic tile furnaces cooperating with room heating systems through warm air. It can be used in classical gravity heating systems or with the use of various types of storage masses. Thanks to the perfectly matched combustion parameters, the optimizer conducts the combustion process in such a way as to ensure its cleanest course and thus protect storage masses against dirt. After passing the firing-up phase on the so-called "Chimney shortcut", the optimizer gives a signal for redirection of flue gas into the heat storage module. This is indicated by the icon  and an audible signal on the upper panel beam. In case of using a chimney flap drive (description in p. 10.3), this is done automatically. After consuming the fuel and lowering the temperature of the furnace - the air damper cuts off the storage module so that it does not cool down and directs the flue gases to the chimney shortcut again - the icon  is turned off and an acoustic signal is emitted. If the chimney flap drive is not used - its operation is carried out manually when the appropriate phases of burning and the above mentioned signalling are reached. It is also possible, instead of the flap actuator, to connect the 230V signalling lamp to the flap drive contact or, for example, the furnace housing lighting, which significantly helps manual handling of this type of set.

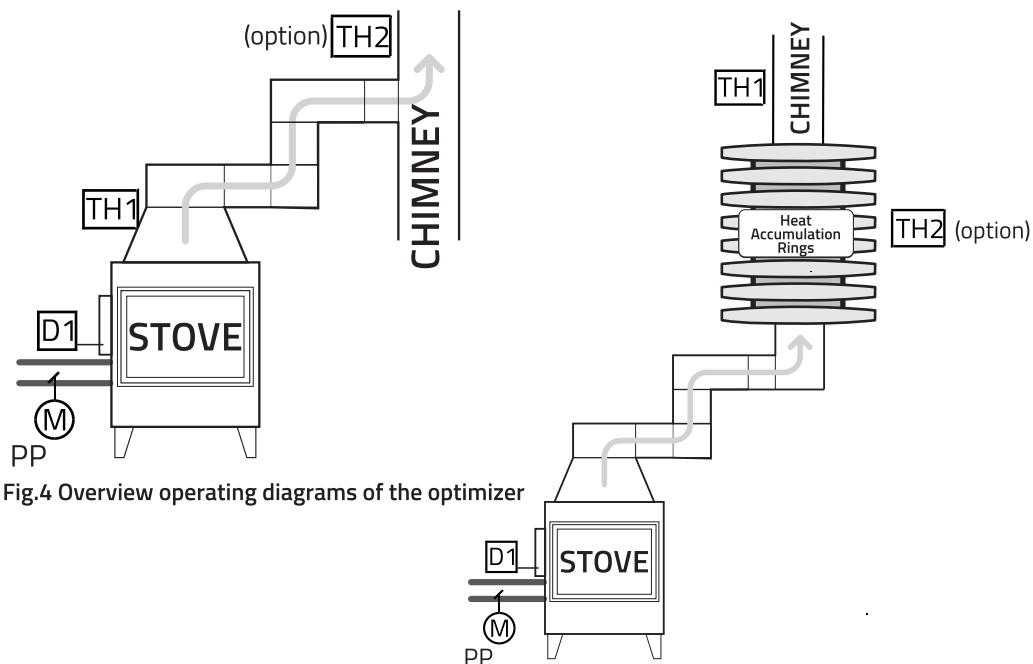



Fig.4 Overview operating diagrams of the optimizer

- TH1- Combustion temperature sensor
 TH2- Temperature sensor of flue gas (option)
 - for the RT-08 OM GRAFIK II controller it's standard!
 D1- Open-door sensor (option)
 PP- Controlled air damper

11.3.4 Setting the time

- (1) Day of the week (1-Monday / 7-Sunday)
- (2) Hour
- (3) Minute
- (4) Accurate frequency correction of the clock

The set field (1) / (2) / (3) should be touched (then it will become brighter) and then change with touch-fields  

After making changes, the data is automatically stored in the optimizer's memory.

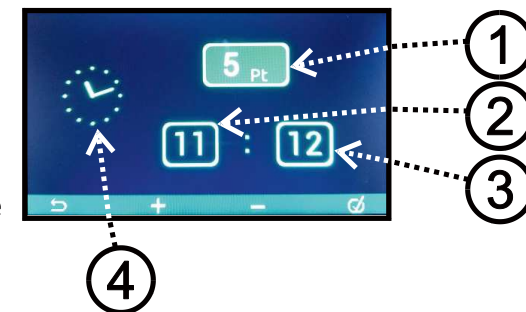

11.3.5 Setting of sound signalling

Touch the field of the selected option. After making changes, the data is automatically stored in the optimizer's memory.

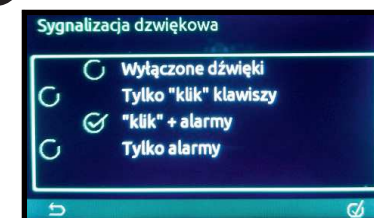

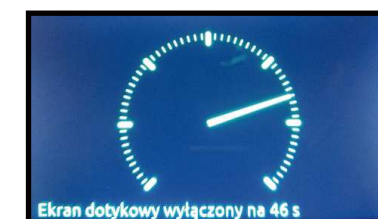

11.3.6 Switching off the touch screen for cleaning the "glass"

The touch screen will be turned off for 60 seconds. This makes it possible to clean the "glass". The elapsed time is displayed in the form of a clock measuring the time to reactivate the touch panel.



11.3.7 Brightness and duration of the display backlight

Touch the set field and then change with  
 After making changes, the data is automatically stored in the optimizer's memory.



11.3 System settings (touch field)

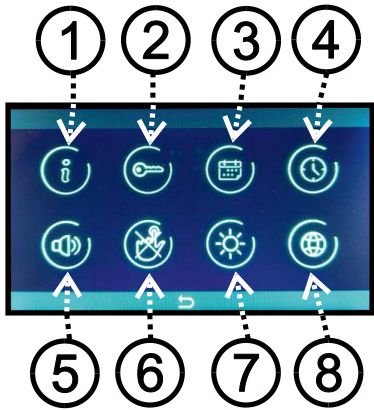

The following functions can be called up in the system settings:

- (1) Information about the optimizer version / configuration
- (2) Entering the password
- (3) Setting the current date
- (4) Setting the current time
- (5) Type of sound signalling
- (6) Switching off the touch screen for cleaning the "glass"
- (7) Brightness and duration of the display backlight
- (8) Choice of language version

11.3.1 Informations

The versions of the installed software are displayed and after the word "config" the current status of all configuration parameters (e.g. 95 (1) indicates that the parameter <95> V.AC = 1).

11.3.2 Entering the password

Some „strategic“ parameters can be changed with the password entered (4-digit PIN). After acceptance, the password is active for 30 minutes. After this time, you must enter it again.

- (1) The field of the last digit entered (displays the currently selected code digit)
- (2) Password acceptance
- (3) Numeric field



11.3.3 Setting the date

Some „strategic“ parameters can be changed with the password entered (4-digit PIN). After acceptance, the password is active for 30 minutes. After this time, you must enter it again.



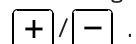

- (1) Year
- (2) Day
- (3) Month

The set field (1) / (2) / (3) should be touched (then it will become brighter) and then change with touch-fields



After making changes, the data is automatically stored in the optimizer's memory.

9. Control of the hydraulic system

The operation of the water system is activated in the context menu  on the bottom navigation bar  in the parameter setting menu .

Select the position **011 CONFIGURATION** and then go to the parameter No. <94> V.NW - then select one of the operation options that is right for the applied system, where "0" means operation without the water base (air stove), and "1" or "2" - selection of operation with the water base and the proper variant of its operation (description in point 10.2)

The heat generated in the stove thanks to the water jacket or the water base is transferred to the buffer tank or directly to the heater system. By controlling the combustion process, the temperature of the water in the stove and in the upper and lower part of the buffer tank, the optimizer controls the buffer loading pump (P.BUF) or a more elaborate system with Laddomat. A circulating pump (P.CO) can be connected to the buffer tank that transfers the stored heat to the further part of the installation.

- The P.CO circulating pump turns on when the buffer upper part temperature is higher than <66> T.P3 = 40 °C.

! The switching of the pumps is additionally controlled by temperature and time hysteresis (see parameter description p.12 --- 005-009).

! Failure of one of the water temperature sensors of the buffer switches to the simplified operation mode. There is no distinction between upper and lower zone, only one common, measured by an efficient sensor.

! **OPERATION WITHOUT THE BUFFER** - failure to connect (or failure of) both sensors of the water temperature of the buffer causes that the optimizer operates in the system as the one without a buffer (fig. 7).

! By default, the buffer loading pump runs when the combustion is in progress. Setting <50> TS.P1 = 0 °C disables the influence of the flue gas temperature on the operation of the P.BUF pump.

! The controller protects the installation against freezing by automatically switching on the pump when the temperature of the circuit in which it works is lower than 4 °C.

! The controller performs the off-season pump run - the pump will turn on for 30s if it has not worked for 5 days and additionally if it did not work within the first 5 minutes after turning on the controller power supply (after the heating season it is required to leave the controller turned on or periodically turn it on for 10 minutes).).

! Pump rundown can also be performed at any time by switching the pumps on in the test mode by invoking "013-OUTPUTS" in the "Parameter settings" menu (see section 12).

9.1 System with the buffer pump

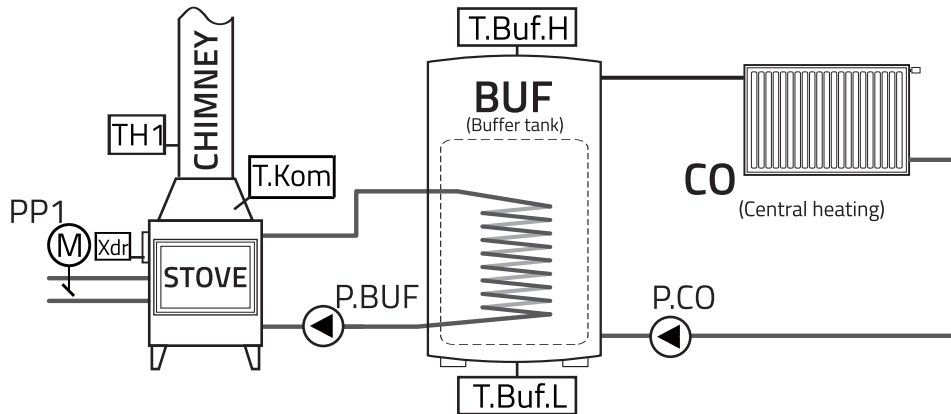

Fig.5 Block diagram of using the optimizer to operate the water system with a pump loading the heat buffer

PP1-	Air damper
P.BUF-	Buffer loading pump
P.CO-	Circulating pump
TH1-	Combustion temperature sensor
T.Kom-	Water temperature sensor of the stove
T.Buf.H-	Buffer upper part temperature sensor
T.Buf.L-	Buffer lower part temperature sensor
Xdr-	Open-door sensor

The buffer pump P.BUF runs by loading the buffer when the following conditions are met:

- The combustion process is in progress, i.e. the combustion temperature is above <50> $TS.P1 = 80\text{ }^{\circ}\text{C}$
- Water temperature in the stove is higher than <51> $T.P1 = 45\text{ }^{\circ}\text{C}$
- Water temperature in the stove is higher than in the lower part of the buffer by <52> $dT.P1 = 3\text{ }^{\circ}\text{C}$

In addition, when the combustion ended but

- Temperature in the stove approaches the alarm one <17> $T.KOM.max = 95\text{ }^{\circ}\text{C}$ by less than $10\text{ }^{\circ}\text{C}$
- The P.CO circulating pump turns on when the buffer upper part temperature is above <66> $T.P3 = 40\text{ }^{\circ}\text{C}$.

! OPERATION WITHOUT THE BUFFER - failure to connect (or damage of) both sensors of the water temperature of the buffer causes that the optimizer works in a system as one without a buffer. P.BUF acts as a circulating pump and runs when:

- The combustion process is in progress, i.e. the combustion temperature is above <50> $TS.P1 = 80\text{ }^{\circ}\text{C}$

Setting <50> $TS.P1 = 0\text{ }^{\circ}\text{C}$ disables the influence of the flue gas temperature on the operation of the P.BUF pump.

- Water temperature in the stove is higher than <51> $T.P1 = 45\text{ }^{\circ}\text{C}$
- The P.CO pump operates identically to P.BUF

11.2 Operating screens

The optimizer operating screens consist of: a main field containing the presented information and a top and bottom navigation bars.

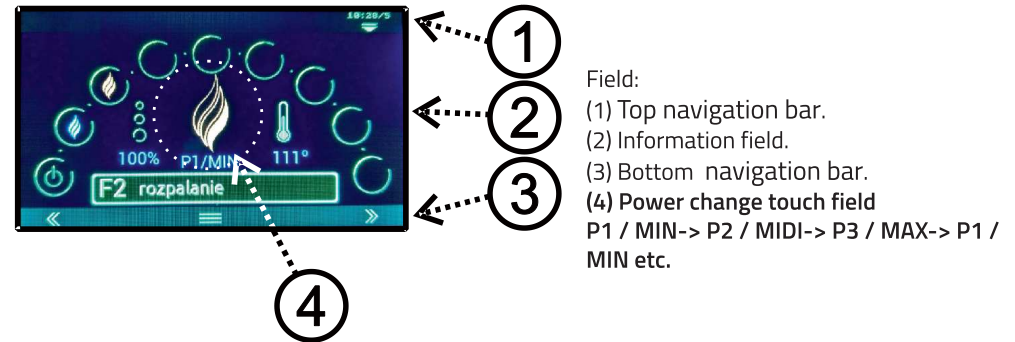

On the top bar, depending on the current state of the optimizer, there are:

- touch field of information about the current alarm
- touch field of system settings
- icon informing about manual work
- icon informing about temporarily blocking the work of the water base
- icon informing about the switch-on of the storage mass (the flap directs the flue gas to the storage mass AC)- it also emits a sound signal of the necessity for changing the position of the flap.
- text information related to the operation of the optimizer

There are navigation fields on the bottom bar:

- touch field and to go to the previous / next screen
- touch field calling the context menu (specific for a given screen)
- touch field to return to the previous / higher up-level screen
- touch-screen to delete
- touch field and of up / down transitions
- touch field and of increase / decrease
- touch field that triggers additional information
- touch field of confirmation

11.1 Start screen

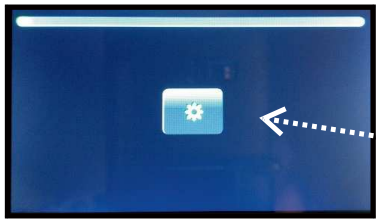

When power is turned on, the start screen appears on the display, indicating that the optimizer is waiting for service (e.g. software update). The displayed bar (1) indicates the elapsed time to start. If the field (2) is touched during this time, the service screen will be displayed.

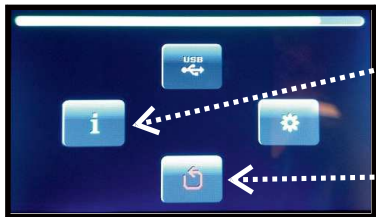

If the field (1) is touched on the service screen, information about the versions of the installed software will be displayed. Touching (2) will exit the start screen. Other fields call service activities and will be described in Chapter 14.



Information about the versions of the installed software. Touching field (1) extends the display time and (2) will exit the start screen.

9.2 Laddomat system (depending on the combustion temperature)

! Laddomat includes an internal thermostatic water valve, so the optimizer controls only in function of the combustion temperature. The valve ensures quick heating of the water jacket and then gradually transferring energy to the buffer. The temperature sensors of the buffer are not required for the loading pump, although the upper sensor ensures correct operation of the pump P.CO- it does not allow to cool down the CH system with the buffer empty.

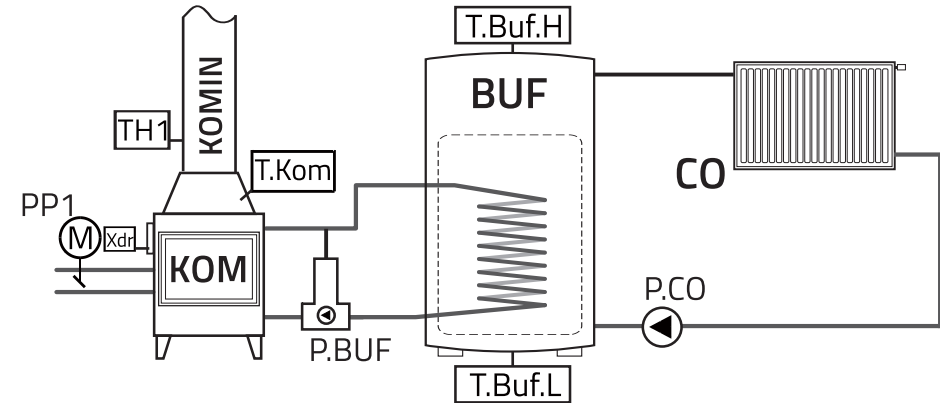

Fig.6 Block diagram of using the optimizer to operate the water system with Laddomat feeding the heat buffer

PP1-	Air damper
P.BUF-	Laddomat pump
P.CO-	Circulating pump
TH1-	Combustion temperature sensor
T.Kom-	Water temperature sensor of the stove
T.Buf.H-	Buffer upper part temperature sensor
T.Buf.L-	Buffer lower part temperature sensor
Xdr-	Open-door sensor

The Laddomat pump P.BUF runs by loading the buffer when the following conditions are met:

- The combustion process is in progress, i.e. the combustion temperature is above <50> $TS.P1 = 80^{\circ}C$

In addition, when the combustion ended but

- Temperature in the stove approaches the alarm one <17> $T.KOM.max = 95^{\circ}C$ by less than $10^{\circ}C$
- The P.CO circulating pump turns on when the buffer upper part temperature is above <66> $T.P3 = 40^{\circ}C$.

! The Laddomat version, which is dependent on the combustion temperature, can also be used for the buffer pump in case the water jacket heats up quickly and unevenly.

! **OPERATION WITHOUT THE BUFFER** - failure to connect (or damage of) both sensors of the water temperature of the buffer causes that the optimizer works in a system as one without a buffer. P.BUF acts as a circulating pump and runs when:

- The combustion process is in progress, i.e. the combustion temperature is above <50> $TS.P1 = 80^{\circ}C$

Setting <50> $TS.P1 = 0^{\circ}C$ disables the influence of the flue gas temperature on the operation of the P.BUF pump.

- The P.CO pump operates identically to P.BUF

9.3 System with the transfer of heat directly to the central heating installation

Failure to connect both sensors of the water temperature to the buffer causes that the optimizer operates in a system without the buffer. **P.BUF acts as a circulating pump** and runs if:

- The combustion process is in progress, i.e. the combustion temperature is above $<50>$ **TS.BF = 80 °C** (setting 0 °C disables the function). At that time, the only parameter responsible for starting the pump is the water temperature.
- The **P.CO** pump works identically to **P.BUF**

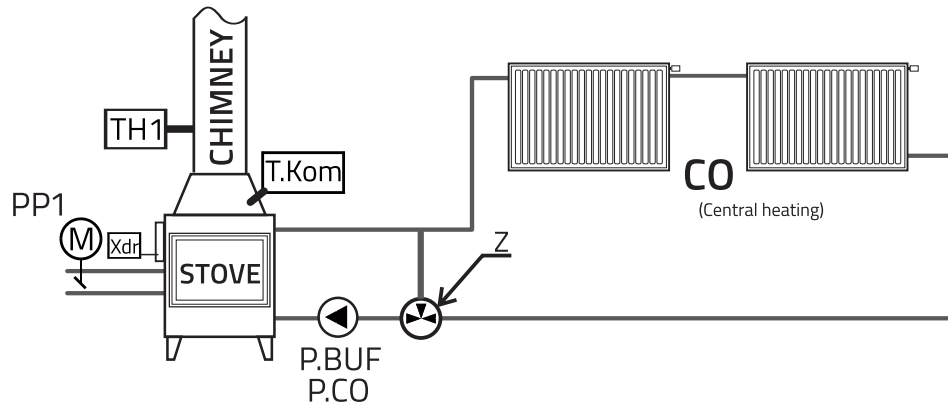
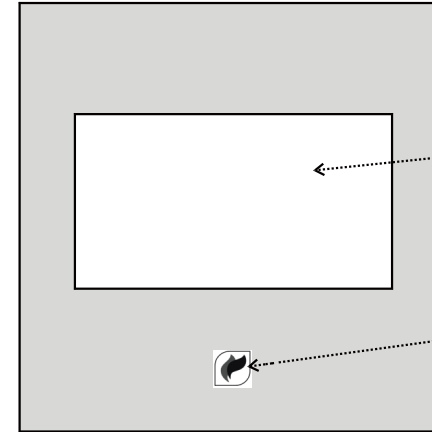

Fig.7 Block diagram of using the optimizer to operate the central heating system directly from the stove.

- PP1- Air damper
- P.BUF- Buffer pump (CO)
- P.CO- Circulating pump
- TH1- Combustion temperature sensor
- T.Kom- Water temperature sensor of the stove
- Xdr- Open-door sensor
- Z- Bimetallic mixing valve ensuring the return of water to the stove at a constant temperature level.

11. How to operate the optimizer

When the optimizer's power supply is turned on, the control panel is activated, in which there are elements controlling the optimizer operation. The device status is indicated by the Indicator light and presented on a graphics display with a touch panel. The control panel is embedded in the installation box by means of four magnets, which enables access to its rear part, where the interface cable connector is located to the **RT181** executive module. There is also a **USB port** for the external memory stick or computer for updating the software.



RT18 control panel - front view:

- 1) Graphics display with a touch panel
- 2) Indicator light – lighting code:
 - ALARM – blinks red
 - STANDBY STATE:
 - (phases F0,F?,Fx) – shines green
 - when the screen is off – pulsating green
 - COMBUSTION STATE:
 - (phases F1-F7) – shines white
 - when the screen is off – pulsating white

To activate the OPERATING SCREEN while the screensaver is on, touch the screen!

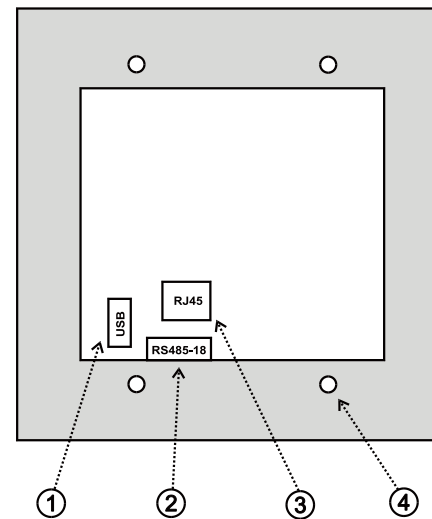

RT18 control panel - back view:

- 1) The **USB** connector for external memory (pendrive)
- 2) The **RS485-18** connector for connection to the RT181 executive module
- 3) The **RJ45** connector for connection to the **RT181** executive module (or to **RS485-18**)
- 4) Magnet (x4) of the control panel mounting it to the installation box.

In the standby, the M.AC output is on. The flap is directed to the AC. Starting the burning process turns off the M.AC output and directs the flue gases directly to the chimney. After completing the F2 firing up phase and reaching the preset temperature $<75> TS.AC$ the flap is switched on and directs the flue gas to the AC.

$<95>V.AC=2$ (opposite to $V.AC=1$):

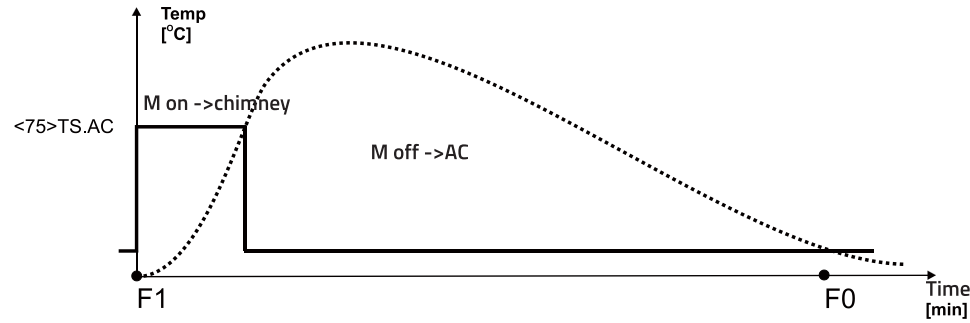

$<95>V.AC=3$:

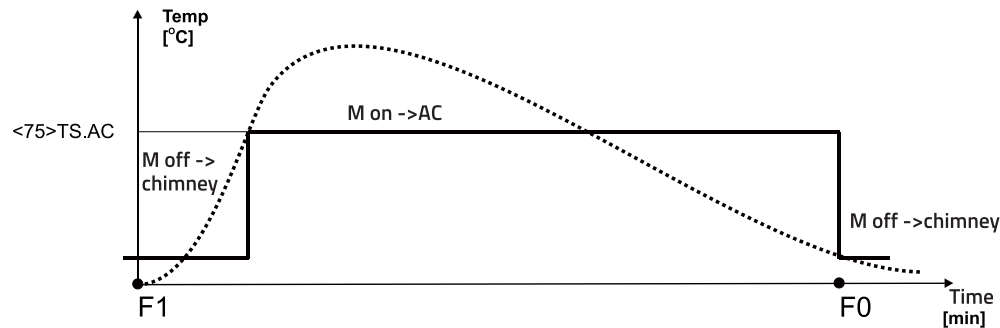

In the standby state, the M.AC output is turned off. The flap is directed to the chimney. After completing the F2 firing-up phase and reaching the preset temperature $<75> TS.AC$ the flap is switched on and directs the flue gas to the AC. After combustion, M.AC is turned off. The flap is directed back to the chimney.

$<95>V.AC=4$ (opposite to $V.AC=3$):

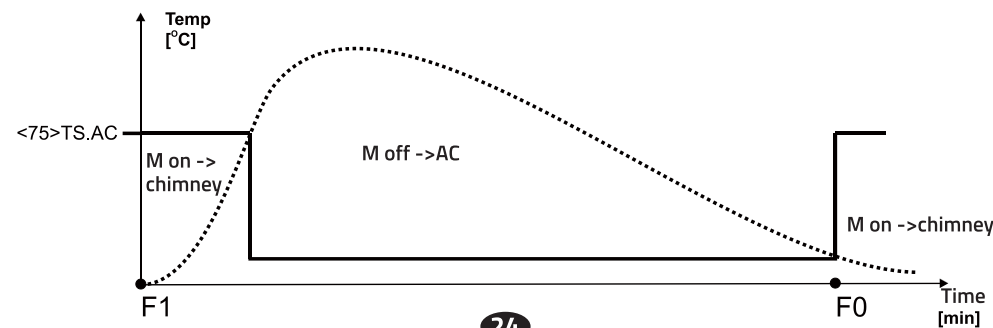

9.4 System MIX – combining the feed of the storage mass with the water base operation.

The VETRO RT-18 optimizer has the ability to operate extensive and advanced heating systems combining both the supply of the storage mass with the operation of the water base on the principle of directing the flue gas into the appropriate heating channels. The construction of this type of systems is entirely dependent on the individual requirements of the system, which obliges to properly select devices that will be used in the installation.

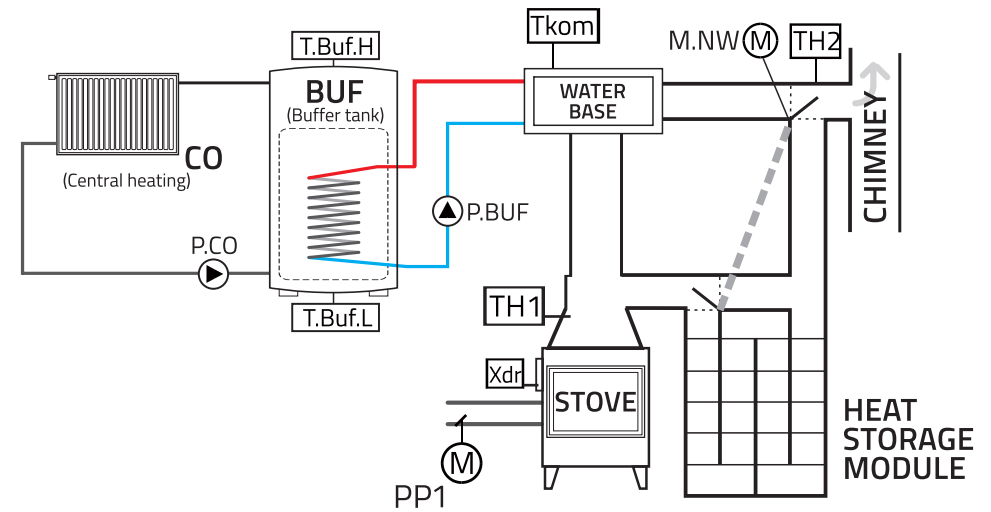

Fig.8 Case block diagram of using the optimizer to operate advanced heating systems combining the feed of the storage mass with the water system operation.

- PP1- Air damper
- P.BUF- Buffer pump (CO)
- P.CO- Circulating pump
- TH1- Combustion temperature sensor
- TH2- Additional flue gas temperature sensor
- T.Kom- Water temperature sensor of the stove
- T.Buf.H- Buffer upper part temperature sensor
- T.Buf.L- Buffer lower part temperature sensor
- M.NW- Flap drive of the water base
- Xdr- Open-door sensor

10. Control of additional circuits

The optimizer is designed to control additional circuits:

- at the **M.GC** output - mechanical ventilation or draught generator
- at the **M.NW** output - the water base flap
- at the **M.AC** output - a flap of storage mass

10.1 Mechanical ventilation or GC draught generator

Depending on the $\langle 93 \rangle$ V.GC parameter setting, we have the following fan control options:

$\langle 93 \rangle$ V.GC=1 Ventilation:

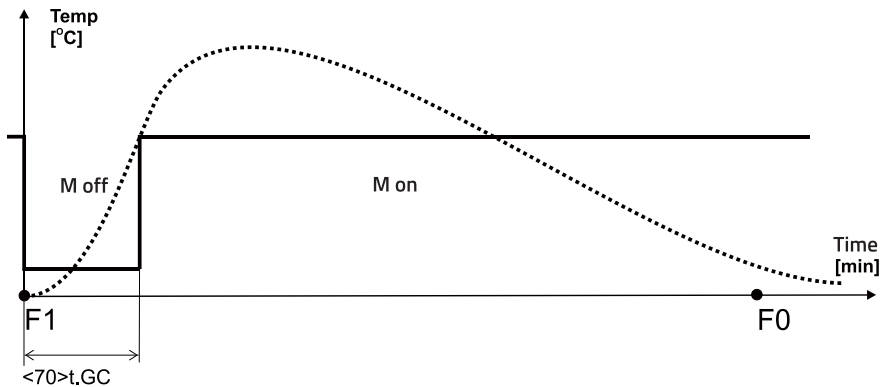

A kitchen hood or mechanical ventilation is connected to the **M.GC** output. The ventilation will be switched off after opening the stove door, which prevents the flue gas from being drawn into the room (open-door sensor required). The ventilation will switch on again after $\langle 70 \rangle$ tGC = 1 minute since closing.

$\langle 93 \rangle$ V.GC=2 Draught generator:

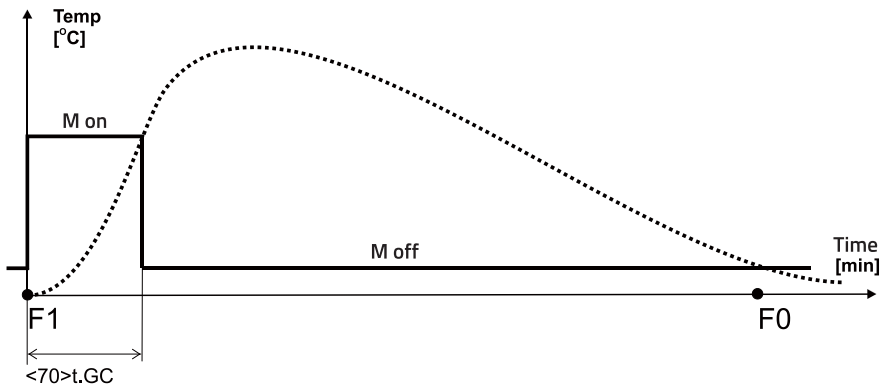

A chimney draught generator is connected to the **M.GC** output. The generator will turn on when the stove door is opened (open-door sensor is necessary) and it will turn off after $\langle 70 \rangle$ tGC = 1 minute since closing.

10.2 The NW water capping/water base flap

Instead of a water jacket, the stove can be equipped with a controlled water base. During normal operation, when there is a demand for hot water, heated combustion gases pass through the water base/cap where they cool down and release heat to the water. During firing-up, when the chimney is cold, its draught may be insufficient - the flap directs the flue gas to the chimney bypassing the NW water base.

After completing the F2 firing-up phase, the air damper actuator will activate NW when:

- Combustion temperature is above $\langle 71 \rangle$ TS.NW = 150 °C
- Water temperature of the NW water base is below $\langle 73 \rangle$ T.NW = 65 °C

The drive will turn the NW water base off when:



- Combustion temperature is below the hysteresis of the flue gas temperature, i.e. $\langle 71 \rangle$ TS.NW - $\langle 72 \rangle$ TSh.NW = 150 °C - 50 °C = 100 °C
- Water temperature of the NW water base is above the hysteresis of the flue gas temperature, i.e. $\langle 73 \rangle$ T.NW + $\langle 74 \rangle$ Th.NW = 65 °C + 20 °C = 85 °C

Depending on the parameter setting $\langle 94 \rangle$ V.NW, we have the following options to control the flap servomotor::

$\langle 94 \rangle$ V.NW = 0: Operation without the NW water base. The air stove.

$\langle 94 \rangle$ V.NW = 1: when the flap drive directs the flue gas directly to the chimney - **M.NW** switched off when the flap drive directs the flue gas through the water base - **M.NW** switched on

$\langle 94 \rangle$ V.NW = 2: when the flap drive directs the flue gas directly to the chimney - **M.NW** switched on (opposite to V.NW=1): when the flap drive directs the flue gas through the water base - **M.NW** switched off

! It is possible to temporarily switch off the water base/cap by clicking the icon  of the context menu  (i.e. fixed setting of the flap to direct the flue gas to the chimney bypassing the NW).

10.3 The AC storage mass flap (Moritz one)

During normal operation, the heated flue gas passes through the **Heat Storage Module (AC)** where it cools down and releases heat. During firing-up, when the chimney is cold, its draught may be insufficient. The optimizer can use the M.AC output to control the bypass flap servomotor. Depending on the servomotor used and the parameter setting $\langle 95 \rangle$ V.AC we have the following options:

$\langle 95 \rangle$ V.AC=1 :

